



IMI.M.M.



P

Разборные

P
Q

IMHypress
IMM Group

Разборной фитинг / Reusable fittings

Страница / Page	2	2	3	3	4	4
Восcola Ferrule						
	0001R SAE 100 R1 - DIN 2SN	0002R SAE 100 R2 - DIN 2SN	0003R SAE 100 R2/R3	0007R SAE 100 R7	0008R MT1	0011R SAE 100 R1T
Страница / Page	5		6	7	8	9
Восcola Ferrule		GAS BSP				
	0021R SAE 100 R2T		0051R BSP Female DKR	0151R BSP 90° Swept Elbow DKR	0251R BSP 45° Swept Elbow DKR	0350R BSP Male 60° AGR
Страница / Page	6	7	8	9		10
60° Metric					NPTF	
	0100R Metric Female DKM	0200R Metric 90° Swept Elbow DKM	0300R Metric 45° Swept Elbow DKM	0400R Metric Male 60° AGM		0370R NPTF Male AGN
Страница / Page	10			11		11
Gas Con. BSPT			Metric Din 24° CEL		Metric Din 24° CES	
	0360R BSPT Male AGR-K			0500R METRIC MALE 24° CEL		0450R METRIC MALE 24° CES
Страница / Page	12	13	14			15
Metric Standpipe					Male JIC 74°	
	0550R Metric Standpipe BES-BEL	0650R 90° Metric Standpipe BES-BEL	0750R 45° Metric Standpipe BES-BEL			0850R Jic Male 74° AGJ
Страница / Page	15	16	16		17	17
Female J17 74°				Banjo		
	0901R Jic Female 74° DKJ	0951R 90° Swept Elbow DKJ	1001R 45° Swept Elbow DKJ		1350R Metric Banjo RNM	1350R Metric Banjo RNM

Dimensions and general characteristics may be changed at any time without prior notice.

Data contained herein are for information purpose only, and it does not enlarge, amend or imply any warranty other than provided by us with the product
Any use of the product not in conformance with our instructions may be dangerous.

0001R Муфта разборная

Reusable Ferrule

для рукава / for hose:
SAE 100 R1 - DIN 2SN

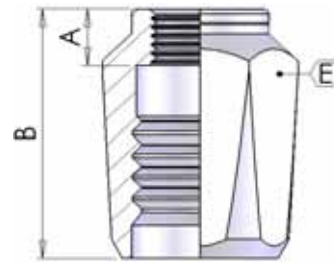

part number	hose I.D.		Dimension			valid for
	in	mm	A	B	E	
0001R04	1/4	6,4	8,5	35	18	R1/2SN
0001R05	5/16	7,9	9,5	38	20	R1/1ST
0001R06	3/8	9,5	10,0	42	22	R1/2SN
0001R08	1/2	12,7	12,5	49	26	R1/2SN
0001R10	5/8	15,9	13,5	53	28	R1/2SN
0001R12	3/4	19	15,0	58	32	R1/2SN
0001R16	1	25,4	20,0	72	42	R1/2SN
0001R20	1.1/4	31,8	23,0	84	55	R1/2SN

0002R Муфта разборная

Reusable Ferrule

для рукава / for hose:
SAE 100 R2 - DIN 2SN

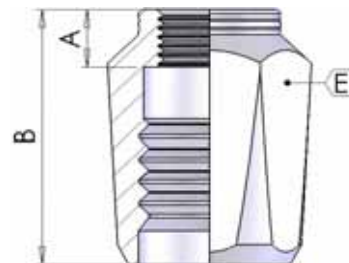

part number	hose I.D.		Dimension			valid for
	in	mm	A	B	E	
0002R04	1/4	6,4	8,5	35	19	R2/2SN
0002R05	5/16	7,9	9,5	38	22	R2/2SN
0002R06	3/8	9,5	10,0	42	24	R2/2ST
0002R08	1/2	12,7	12,5	49	27	R2/2SN
0002R10	5/8	15,9	13,5	53	30	R2/2SN
0002R12	3/4	19	15,0	58	34	R2/2SN
0002R16	1	25,4	20,0	72	45	R2/2SN

0003R Муфта разборная

Reusable Ferrule

для рукава / for hose:

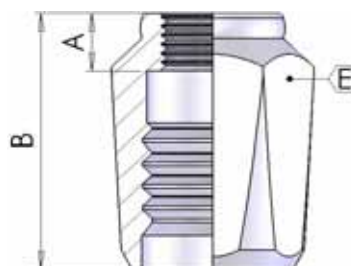
SAE 100 R3 - SAE 100 R5

part number	hose I.D.		Dimension			valid for
	in	mm	A	B	E	
0003R03	3/16	4,8	8,0	28	17	R1/R3/R5
0003R04	1/4	6,4	8,5	35	18	R3/R5
0003R05	5/16	7,9	9,5	38	20	R3/R5
0003R06	3/8	9,5	10,0	42	22	R3/R5
0003R08	1/2	12,7	12,5	49	27	R3/R5
0003R10	5/8	15,9	13,5	53	30	R3/R5
0003R12	3/4	19	15,0	58	36	R3/R5
0005R14	7/8	22,2	18,0	64	36	R5

0007R Муфта разборная

Reusable Ferrule

для рукава / for hose:

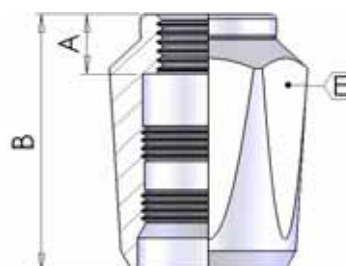
SAE 100 R7

part number	hose I.D.		Dimension			valid for
	in	mm	A	B	E	
0007R03	3/16	4,8	8,0	28	14	R7
0007R04	1/4	6,4	8,5	34	17	R7
0007R05	5/16	7,9	9,5	37	19	R7
0007R06	3/8	9,5	10,0	41	22	R7
0007R08	1/2	12,7	12,5	48	24	R7

0008R Муфта разборная

Reusable Ferrule

для рукава / for hose:

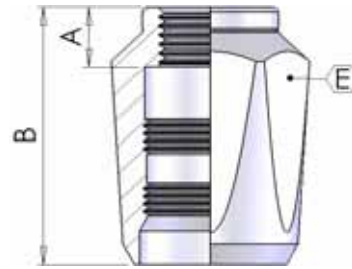
MT1

part number	hose I.D.		Dimension			valid for
	in	mm	A	B	E	
0008R03	3/16	4,8	8,0	28	14	MT1
0008R04	1/4	6,4	8,5	34	17	MT1
0008R05	5/16	7,9	9,5	37	19	MT1
0008R06	3/8	9,5	10,0	41	20	MT1
0008R08	1/2	12,7	12,5	48	24	MT1

0011R Муфта разборная

Reusable Ferrule

для рукава / for hose:

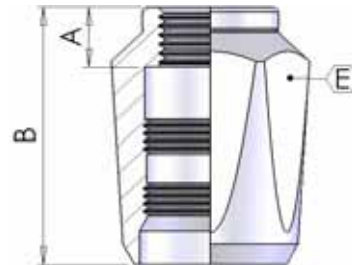
SAE 100 R1T

part number	hose I.D.		Dimension			valid for
	in	mm	A	B	E	
0011R03	3/16	4,8	8,0	28	17	R1T
0011R04	1/4	6,4	8,5	35	18	R1T
0011R05	5/16	7,9	9,5	38	20	R1T
0011R06	3/8	9,5	10,0	42	22	R1T
0011R08	1/2	12,7	12,5	49	26	R1T
0011R10	5/8	15,9	13,5	53	28	R1T
0011R12	3/4	19	15,0	58	32	R1T
0011R16	1	25,4	20,0	72	42	R1T
0011R20	1.1/4	31,8	23,0	84	50	R1T
0011R24	1.1/2	38,1	25,0	88	60	R1T

0021R Муфта разборная

Reusable Ferrule

для рукава / for hose:
SAE 100 R2T

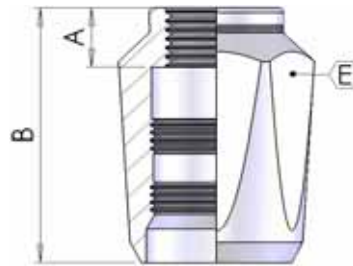

part number	hose I.D.		Dimension			valid for
	in	mm	A	B	E	
0021R04	1/4	6,4	8,5	35	19	R2T
0021R05	5/16	7,9	9,5	38	22	R2T
0021R06	3/8	9,5	10,0	42	24	R2T
0021R08	1/2	12,7	12,5	49	27	R2T
0021R10	5/8	15,9	13,5	53	30	R2T
0021R12	3/4	19	15,0	58	34	R2T
0021R16	1	25,4	20,0	72	45	R2T/R3

0051R Ниппель BSP 60°

BSP Female 60° Cone Rolled Nut

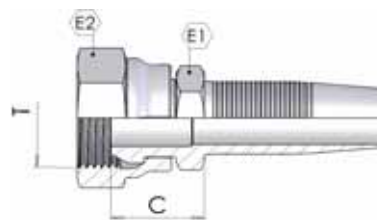

part number	hose I.D.		Dimension				
			dash size	Thread	hex		cut-off
	in	mm		T	E1	E2	C
0051R03-02	3/16	4,8	03	1/8	14	14	16
0051R03-04	3/16	4,8	03	1/4	14	17	17
0051R04-04	1/4	6,4	04	1/4	17	17	17
0051R04-06	1/4	6,4	04	3/8	19	22	18
0051R05-04	5/16	7,9	05	1/4	17	17	17
0051R05-06	5/16	7,9	05	3/8	19	22	19
0051R06-06	3/8	9,5	06	3/8	22	22	20
0051R06-08	3/8	9,5	06	1/2	24	27	22
0051R08-08	1/2	12,7	08	1/2	27	27	22
0051R08-10	1/2	12,7	08	5/8	27	30	23
0051R10-10	5/8	15,9	10	5/8	30	30	23
0051R10-12	5/8	15,9	10	3/4	30	32	24
0051R12-12	3/4	19	12	3/4	32	32	25
0051R16-16	1	25,4	16	1	38	38	28
0051R20-20	1.1/4	31,8	20	1.1/4	50	50	32
0051R24-24	1.1/2	38,1	24	1.1/2	55	55	34

0100R Ниппель метрика 60°

Metric Female 60° cone

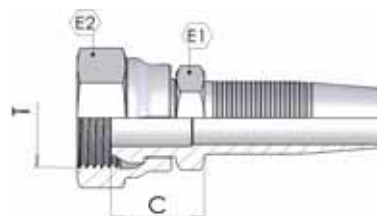

part number	hose I.D.		Dimension				
			dash size	Thread	hex		cut-off
	in	mm		T	E1	E2	C
0100R03-10	3/16	4,8	03	M10-1	14	14	16
0100R04-12	1/4	6,4	04	M12-1,5	17	17	17
0100R04-14	1/4	6,4	04	M14-1,5	17	19	17
0100R04-16	1/4	6,4	04	M16-1,5	18	22	22
0100R05-14	5/16	7,9	05	M14-1,5	17	27	17
0100R05-16	5/16	7,9	05	M16-1,5	19	22	22
0100R05-18	5/16	7,9	05	M18-1,5	19	24	22
0100R06-16	3/8	9,5	06	M16-1,5	20	22	22
0100R06-18	3/8	9,5	06	M18-1,5	20	24	22
0100R06-22	3/8	9,5	06	M22-1,5	22	27	27
0100R08-18	1/2	12,7	08	M18-1,5	22	24	27
0100R08-22	1/2	12,7	08	M22-1,5	22	27	27
0100R10-26	5/8	15,9	10	M26-1,5	24	32	32
0100R12-26	3/4	19	12	M26-1,5	25	32	32

0151R Ниппель 90° BSP 60°

BSP 90° Swept Elbow 60° Cone Rolled Nut

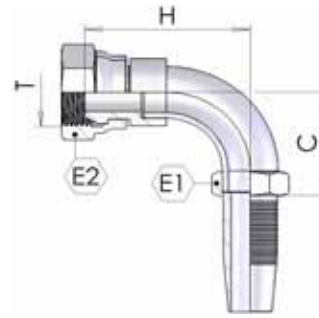

part number	hose I.D.		Dimension					
			dash size	Thread	hex		drop	cut-off
	in	mm		T	E1	E2	H	C
0151R03-02	3/16	4,8	03	1/8	12	14	27	27
0151R03-04	3/16	4,8	03	1/4	12	17	28	27
0151R04-04	1/4	6,4	04	1/4	14	17	30	30
0151R04-06	1/4	6,4	04	3/8	14	22	34	22
0151R05-04	5/16	7,9	05	1/4	14	17	33	22
0151R05-06	5/16	7,9	05	3/8	14	22	34	24
0151R06-06	3/8	9,5	06	3/8	17	22	37	37
0151R06-08	3/8	9,5	06	1/2	18	27	41	30
0151R08-08	1/2	12,7	08	1/2	20	27	44	41
0151R10-10	5/8	15,9	10	5/8	24	30	46	36
0151R10-12	5/8	15,9	10	3/4	24	32	50	40
0151R12-12	3/4	19	12	3/4	27	32	51	42
0151R12-16	3/4	19	12	1	27	38	53	48
0151R16-16	1	25,4	16	1	32	38	65	50
0151R16-20	1	25,4	16	1.1/4	32	50	63	50
0151R20-20	1.1/4	31,8	20	1.1/4	45	50	69	55
0151R24-24	1.1/2	38,1	24	1.1/2	50	55	90	73

0200R Ниппель 90° метрика 60°

90° Metric Swept Elbow 60° cone

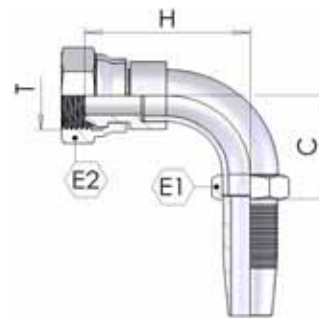

part number	hose I.D.		Dimension					
			dash size	Thread	hex		drop	cut-off
	in	mm		T	E1	E2	H	C
0200R03-10	3/16	4,8	03	M10-1	12	14	27	27
0200R04-12	1/4	6,4	04	M12-1,5	14	17	30	30
0200R04-14	1/4	6,4	04	M14-1,5	14	22	34	22
0200R04-16	1/4	6,4	04	M16-1,5	14	22	34	22
0200R05-14	5/16	7,9	05	M14-1,5	14	17	33	22
0200R05-16	5/16	7,9	05	M16-1,5	14	22	34	24
0200R06-16	3/8	9,5	06	M16-1,5	17	22	37	37
0200R06-18	3/8	9,5	06	M18-1,5	18	27	41	30
0200R06-22	3/8	9,5	06	M22-1,5	18	27	41	30
0200R08-18	1/2	12,7	08	M18-1,5	20	27	44	41
0200R08-22	1/2	12,7	08	M22-1,5	20	27	44	41
0200R10-26	5/8	15,9	10	M26-1,5	24	32	50	40
0200R12-26	3/4	19	12	M26-1,5	27	32	51	42

0251R Ниппель 45° BSP 60°

BSP 45° Swept Elbow 60° Cone Rolled Nut

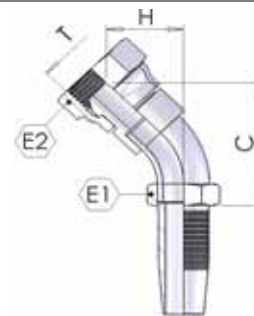

part number	hose I.D.		Dimension					
			dash size	Thread	hex		drop	cut-off
	in	mm		T	E1	E2	H	C
0251R03-02	3/16	4,8	03	1/8	12	14	18	42
0251R03-04	3/16	4,8	03	1/4	12	17	18	42
0251R04-04	1/4	6,4	04	1/4	14	17	19	36
0251R05-06	5/16	7,9	05	3/8	17	22	21	42
0251R06-06	3/8	9,5	06	3/8	17	22	21	42
0251R06-08	3/8	9,5	06	1/2	17	27	28	42
0251R08-08	1/2	12,7	08	1/2	20	27	28	42
0251R10-10	5/8	15,9	10	5/8	24	30	32	53
0251R10-12	5/8	15,9	10	3/4	24	32	32	54
0251R12-12	3/4	19	12	3/4	27	32	35	60
0251R12-16	3/4	19	12	1	27	38	38	65
0251R16-16	1	25,4	16	1	32	38	42	74
0251R20-20	1.1/4	31,8	20	1.1/4	45	50	48	82
0251R24-24	1.1/2	38,1	24	1.1/2	50	55	55	88

0300R Ниппель 45° метрика 60°

45° Metric Swept Elbow 60° cone

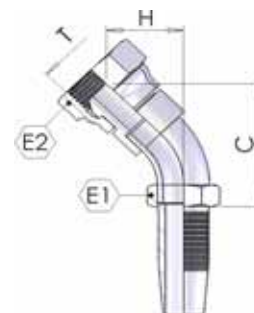

part number	hose I.D.		Dimension					
			dash size	Thread	hex		drop	cut-off
	in	mm		T	E1	E2	H	C
0300R03-10	3/16	4,8	03	M10-1	12	14	18	42
0300R04-12	1/4	6,4	04	M12-1,5	14	17	19	36
0300R04-14	1/4	6,4	04	M14-1,5	14	17	19	36
0300R05-16	5/16	7,9	05	M16-1,5	17	22	21	42
0300R06-16	3/8	9,5	06	M16-1,5	17	22	21	42
0300R06-18	3/8	9,5	06	M18-1,5	17	22	21	42
0300R06-22	3/8	9,5	06	M22-1,5	17	27	28	42
0300R08-22	1/2	12,7	08	M22-1,5	20	27	28	42
0300R10-26	5/8	15,9	10	M26-1,5	24	32	28	54
0300R12-26	3/4	19	12	M26-1,5	17	32	35	60

0350R Штуцер BSP конус 60°

BSP Male Parallel 60° cone

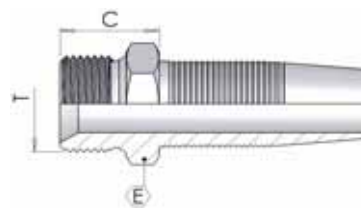

part number	hose I.D.		Dimension			
			dash size	Thread	hex	cut-off
	in	mm		T	E	C
0350R03-02	3/16	4,8	03	1/8	14	16
0350R04-04	1/4	6,4	04	1/4	17	17
0350R04-06	1/4	6,4	04	3/8	19	21
0350R05-06	5/16	7,9	05	3/8	22	22
0350R06-06	3/8	9,5	06	3/8	22	22
0350R06-08	3/8	9,5	06	1/2	27	23
0350R08-08	1/2	12,7	08	1/2	27	23
0350R10-10	5/8	15,9	10	5/8	30	24
0350R10-12	5/8	15,9	10	3/4	32	26
0350R12-12	3/4	19	12	3/4	32	26
0350R12-16	3/4	19	12	1	38	30
0350R16-16	1	25,4	16	1	38	30

0400R Штуцер метрика 60°

Metric Male 60° cone

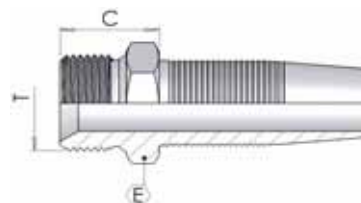

part number	hose I.D.		Dimension			
			dash size	Thread	hex	cut-off
	in	mm		T	E	C
0400R03-10	3/16	4,8	03	M10-1	14	16
0400R04-14	1/4	6,4	04	M14-1,5	17	17
0400R05-16	5/16	7,9	05	M16-1,5	22	22
0400R06-16	3/8	9,5	06	M16-1,5	22	22
0400R06-18	3/8	9,5	06	M18-1,5	24	23
0400R08-22	1/2	12,7	08	M22-1,5	27	24
0400R10-26	5/8	15,9	10	M26-1,5	32	26

0360R Штуцер BSPT конус 60°

BSP Taper Male 60° cone

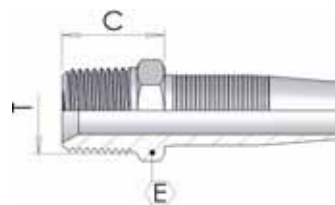

part number	hose I.D.		Dimension			
			dash size	Thread	hex	cut-off
	in	mm		T	E	C
0360R03-02	3/16	4,8	03	1/8	14	16
0360R04-04	1/4	6,4	04	1/4	7	16
0360R05-06	5/16	7,9	05	3/8	19	23
0360R06-06	3/8	9,5	06	3/8	19	23
0360R06-08	3/8	9,5	06	1/2	22	26
0360R08-08	1/2	12,7	08	1/2	24	27
0360R10-12	5/8	15,9	10	3/4	30	30
0360R12-12	3/4	19	12	3/4	30	30
0360R16-16	1	25,4	16	1	36	35
0360R20-20	1.1/4	31,8	20	1.1/4	45	38
0360R24-24	1.1/2	38,1	24	1.1/2	50	39

0370R Штуцер NPTF конус 60°

NPTF Male 60° cone

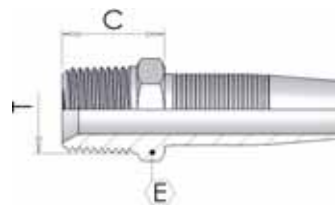

part number	hose I.D.		Dimension			
			dash size	Thread	hex	cut-off
	in	mm		T	E	C
0370R04-04	1/4	6,4	04	1/4	17	16
0370R05-04	5/16	7,9	05	1/4	17	18
0370R06-06	3/8	9,5	06	3/8	19	23
0370R06-08	3/8	9,5	06	1/2	22	26
0370R08-08	1/2	12,7	08	1/2	24	27
0370R10-12	5/8	15,9	10	3/4	30	30
0370R12-12	3/4	19	12	3/4	30	30
0370R14-16	7/8	22,2	14	1	30	32

0450R Штуцер метрический конус 24°, S

Metric Male 24° Seat Heavy

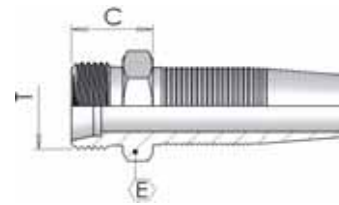

part number	hose I.D.		Dimension				
			dash size	Thread	<i>Erm</i>	hex	cut-off
	in	mm		T		E	
0450R04-18	1/4	6,4	04	M18-1,5	10	19	19
0450R06-22	3/8	9,5	06	M22-1,5	14	22	22
0450R08-24	1/2	12,7	08	M24-1,5	16	24	23

0500R Штуцер метрика 24° L

Metric Male 24° Seat Light

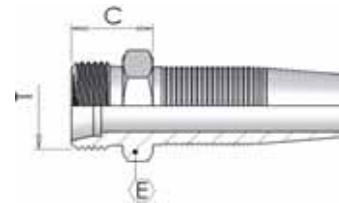

part number	hose I.D.		Dimension				
			dash size	Thread	<i>Erm</i>	hex	cut-off
	in	mm		T		E	
0500R04-14	1/4	6,4	04	M14-1,5	8	17	18
0500R05-16	5/16	7,9	05	M16-1,5	10	17	20
0500R06-18	3/8	9,5	06	M18-1,5	12	19	21
0500R08-22	1/2	12,7	08	M22-1,5	15	24	23

0550R Трубка прессуемая метрическая

Metric Standpipe

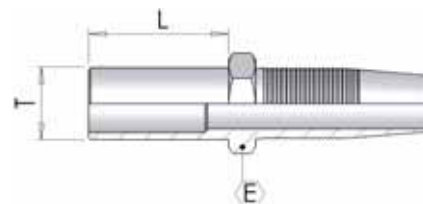

part number	hose I.D.		Dimension				
			dash size	Pipe	type	hex	
	in	mm		T		E	L
0550R03-04	3/16	4,8	03	4	L	10	5
0550R03-06	3/16	4,8	03	6	L	12	5
0550R03-08	3/16	4,8	03	8	S	12	7
0550R04-06	1/4	6,4	04	6	L-S	12	7
0550R04-08	1/4	6,4	04	8	L-S	12	7
0550R04-10	1/4	6,4	04	10	L-S	12	7
0550R04-12	1/4	6,4	04	12	L-S	14	7
0550R05-08	5/16	7,9	05	8	L-S	14	8
0550R05-10	5/16	7,9	05	10	L-S	14	8
0550R05-12	5/16	7,9	05	12	L-S	14	8
0550R06-10	3/8	9,5	06	10	L-S	17	8
0550R06-12	3/8	9,5	06	12	L-S	17	8
0550R06-14	3/8	9,5	06	14	S	17	8
0550R06-15	3/8	9,5	06	15	L	17	8
0550R08-15	1/2	12,7	08	15	L	19	9
0550R08-16	1/2	12,7	08	16	S	19	9
0550R08-18	1/2	12,7	08	18	L	19	9
0550R10-18	5/8	15,9	10	18	L	22	9
0550R10-20	5/8	15,9	10	20	S	22	9
0550R12-20	3/4	19	12	20	S	27	10
0550R12-22	3/4	19	12	22	L	27	10
0550R12-25	3/4	19	12	25	S	27	10
0550R16-28	1	25,4	16	28	L	32	12
0550R16-30	1	25,4	16	30	S	32	12

0650R Трубка прессуемая метрическая 90°

90° Metric Standpipe

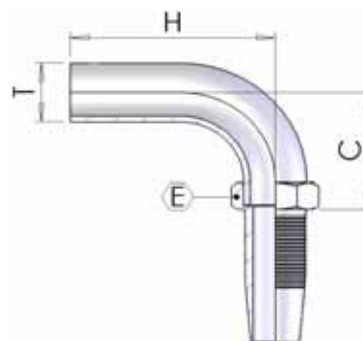

part number	hose I.D.		Dimension					
			dash size	Pipe	type	hex	drop	cut-off
	in	mm		T		E	H	C
0650R03-04	3/16	4,8	03	4	L	12	30	21
0650R03-06	3/16	4,8	03	6	L	12	34	22
0650R03-08	3/16	4,8	03	8	S	12	37	23
0650R04-06	1/4	6,4	04	6	L-S	12	37	23
0650R04-08	1/4	6,4	04	8	L-S	14	38	25
0650R04-10	1/4	6,4	04	10	L-S	14	41	24
0650R04-12	1/4	6,4	04	12	L-S	17	45	34
0650R05-08	5/16	7,9	05	8	L-S	14	37	24
0650R05-10	5/16	7,9	05	10	L-S	14	41	26
0650R05-12	5/16	7,9	05	12	L-S	17	46	28
0650R06-10	3/8	9,5	06	10	L-S	17	46	25
0650R06-12	3/8	9,5	06	12	L-S	17	43	29
0650R06-14	3/8	9,5	06	14	S	19	53	35
0650R06-15	3/8	9,5	06	15	L	19	43	33
0650R08-15	1/2	12,7	08	15	L	20	55	37
0650R08-16	1/2	12,7	08	16	S	20	55	37
0650R08-18	1/2	12,7	08	18	L	22	58	41
0650R10-18	5/8	15,9	10	18	L	24	60	41
0650R10-20	5/8	15,9	10	20	S	24	65	42
0650R12-20	3/4	19	12	20	S	27	65	42
0650R12-22	3/4	19	12	22	L	27	67	48
0650R12-25	3/4	19	12	25	S	30	74	53
0650R16-28	1	25,4	16	28	L	32	76	55

0750R Трубка прессуемая метрическая 45°

45° Metric Standpipe

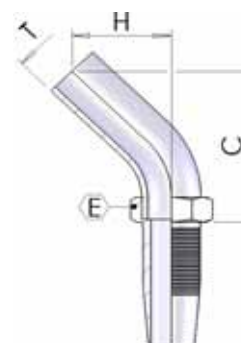

part number	hose I.D.		Dimension					
			dash size	Pipe	type	hex	drop	cut-off
	in	mm		T		E	H	C
0750R03-04	3/16	4,8	03	4	L	12	19	36
0750R03-06	3/16	4,8	03	6	L	12	19	36
0750R04-06	1/4	6,4	04	6	L-S	12	21	38
0750R04-08	1/4	6,4	04	8	L-S	14	22	42
0750R04-10	1/4	6,4	04	10	L-S	14	22	44
0750R05-10	5/16	7,9	05	10	L-S	14	23	44
0750R05-12	5/16	7,9	05	12	L-S	17	24	45
0750R06-12	3/8	9,5	06	12	L-S	19	28	50
0750R06-14	3/8	9,5	06	14	S	19	28	55
0750R08-15	1/2	12,7	08	15	L	19	28	55
0750R08-16	1/2	12,7	08	16	S	24	28	56
0750R10-18	5/8	15,9	10	18	L	27	30	60
0750R10-20	5/8	15,9	10	20	S	27	33	64
0750R12-22	3/4	19	12	22	L	32	35	68
0750R12-25	3/4	19	12	25	L	32	37	72

0850R Штуцер JIC конус 74°

JIC Male 74° cone

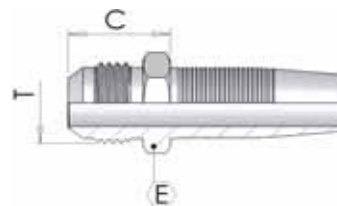

part number	hose I.D.		Dimension			
			dash size	Thread	hex	
	in	mm		T	E	
0850R04-05	1/4	6,4	04	1/2-20	14	17
0850R05-06	5/16	7,9	05	9/16-18	17	23
0850R06-08	3/8	9,5	06	3/4-16	19	25
0850R08-10	1/2	12,7	08	7/8-14	24	28

0901R Ниппель JIC 74°

JIC Female 74° cone

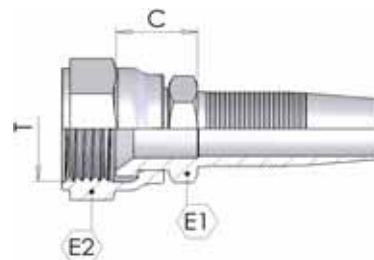

part number	hose I.D.		Dimension				
			dash size	Thread	hex		cut-off C
	in	mm		T	E1	E2	
0901R03-04	3/16	4,8	03	7/16-20	14	15	14
0901R03-05	3/16	4,8	03	1/2-20	14	17	15
0901R04-04	1/4	6,4	04	7/16-20	14	18	14
0901R04-05	1/4	6,4	04	1/2-20	17	17	15
0901R04-06	1/4	6,4	04	9/16-18	17	19	16
0901R05-06	5/16	7,9	05	9/16-18	19	19	16
0901R06-06	3/8	9,5	06	9/16-18	19	19	16
0901R06-08	3/8	9,5	06	3/4-16	22	24	17
0901R08-08	1/2	12,7	08	3/4-16	24	24	18
0901R08-10	1/2	12,7	08	7/8-14	27	27	20
0901R10-10	5/8	15,9	10	7/8-14	27	27	20
0901R10-12	5/8	15,9	10	1.1/16-12	30	32	22
0901R12-12	3/4	19	12	1.1/16-12	32	32	22
0901R16-16	1	25,4	16	1.5/16-12	38	38	25

0951R Ниппель 90° JIC 74°

JIC 90° Swept Elbow 74° cone

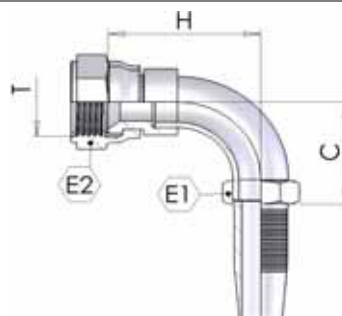

part number	hose I.D.		Dimension					
			dash size	Thread	hex		drop	cut-off
	in	mm		T	E1	E2	H	C
0951R03-04	3/16	4,8	03	7/16-20	12	15	25	22
0951R03-05	3/16	4,8	03	1/2-20	12	17	25	24
0951R04-04	1/4	6,4	04	7/16-20	14	15	27	22
0951R04-05	1/4	6,4	04	1/2-20	14	17	28	27
0951R04-06	1/4	6,4	04	9/16-18	14	19	29	25
0951R05-06	5/16	7,9	05	9/16-18	14	19	29	25
0951R06-06	3/8	9,5	06	9/16-18	17	19	31	26
0951R06-08	3/8	9,5	06	3/4-16	17	24	35	30
0951R08-08	1/2	12,7	08	3/4-16	20	24	38	32
0951R08-10	1/2	12,7	08	7/8-14	20	27	56	38
0951R10-12	5/8	15,9	10	1.1/16-12	24	32	52	39
0951R12-12	3/4	19	12	1.1/16-12	27	32	53	41
0951R16-16	1	25,4	16	1.5/16-12	32	38	62	52

1001R Ниппель 45° JIC 74°

JIC 45° Swept Elbow 74° Cone

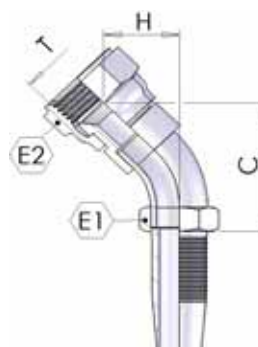

part number	hose I.D.		Dimension					
			dash size	Thread	hex		drop	cut-off
	in	mm		T	E1	E2	H	C
1001R03-04	3/16	4,8	03	7/16-20	12	15	21	40
1001R04-04	1/4	6,4	04	7/16-20	14	15	27	40
1001R04-05	1/4	6,4	04	1/2-20	14	17	22	42
1001R04-06	1/4	6,4	04	9/16-18	14	19	25	47
1001R05-06	5/16	7,9	05	9/16-18	14	19	22	47
1001R06-08	3/8	9,5	06	3/4-16	17	24	30	51
1001R08-10	1/2	12,7	08	7/8-14	20	27	30	55
1001R10-12	5/8	15,9	10	1.1/16-12	24	32	34	64
1001R12-12	3/4	19	12	1.1/16-12	27	32	34	66
1001R16-16	1	25,4	16	1.5/16-12	32	38	35	70

1400R **BSP Banjo**

BSP Banjo

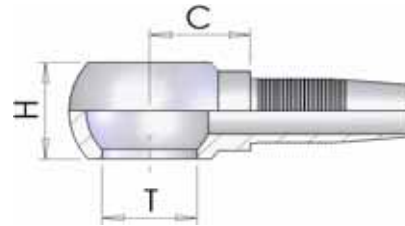

part number	hose I.D.		dash size	Dimension		
	in	mm		Hole T	H	cut-off C
1400R03-02	3/16	4,8	03	1/8	11	17
1400R03-04	3/16	4,8	03	1/4	14	22
1400R04-02	1/4	6,4	04	1/8	11	20
1400R04-04	1/4	6,4	04	1/4	14	22
1400R04-06	1/4	6,4	04	3/8	17	26
1400R05-06	5/16	7,9	05	3/8	17	26
1400R06-06	3/8	9,5	06	3/8	17	26
1400R06-08	3/8	9,5	06	1/2	22	30
1400R08-08	1/2	12,7	08	1/2	22	30
1400R10-12	5/8	15,9	10	3/4	28	38
1400R12-12	3/4	19	12	3/4	28	38

1350R **Метрический банджо**

Metric Banjo

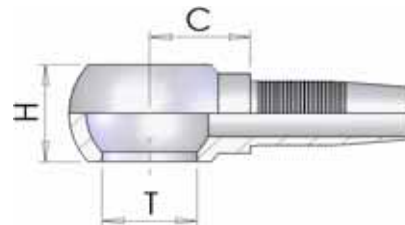

part number	hose I.D.		dash size	Dimension		
	in	mm		Hole T	H	cut-off C
1350R03-10	3/16	4,8	03	M10	11	17
1350R04-10	1/4	6,4	04	M10	11	20
1350R04-12	1/4	6,4	04	M12	12	21
1350R04-14	1/4	6,4	04	M14	15	22
1350R05-16	5/16	7,9	05	M16	17	26
1350R05-18	5/16	7,9	05	M18	20	26
1350R06-18	3/8	9,5	06	M18	20	26
1350R06-20	3/8	9,5	06	M20	22	30
1350R08-18	1/2	12,7	08	M18	20	26

