



IMM M.M.



L

Мультиспиральные ниппеля

L
M



IMM Hypress
IMM Group





● ● ● ● ● Ниппель спиральный рукав / Multispiral tail

Страница / Page		3	3	4		5			
Ferrule Воскола				BSP					
		0019 R9 - 4SP - 4SH	BMC2 Spiral No Skive			0350M BSP MALE 60° seat AGR	0050M BSP FEMALE 60° R DKR		
Страница / Page		5	5	6	6	7	7		
				JIC					
		0150M 90° Swept Elbow R DKR-90°	0250M 45° Swept Elbow R DKR-45°	0850M JIC MALE 37° AGJ	0900M JIC FEMALE 37° R DKJ	0950M 90° Swept Elbow R DKJ-90°	1000M 45° Swept Elbow R DKJ-45°		
Страница / Page		4	8		8	9	9		
NPTF male			CEL / DKOL						
		0370M NPTF MALE 60° seat AGN			0500M METRIC MALE 24° CEL	0085M FEMALE 24° OR DKOL	0185M 90° Swept Elbow OR DKOL-90°	0285M 45° Swept Elbow OR DKOL-45°	
Страница / Page		10	10	11	11				
CES / DKOS									
		0450M METRIC MALE 24° CES	0084M FEMALE 24° OR DKOS	0184M 90° Swept Elbow OR DKOS-90°	0284M 45° Swept Elbow OR DKOS-45°				
Страница / Page		12	12	13	13	14	14		
SAE flange									
		1250M 3000 psi SOLID SFL	1050M 3000 psi SOLID 90° SFL 90°	1150M 3000 psi SOLID 45° SFL 45°	1300M 6000 psi SOLID SFS	1100M 6000 psi SOLID 90° SFS 90°	1200M 6000 psi SOLID 45° SFS 45°		
Страница / Page		15	15	15					
Super CAT									
		130SM 9000 psi SOLID SFC	110SM 9000 psi SOLID 90° SFC 90°	120SM 9000 psi SOLID 45° SFC 45°					

Dimensions and general characteristics may be changed at any time without prior notice.

Data contained herein are for information purpose only, and it does not enlarge, amend or imply any warranty other than provided by us with the product
Any use of the product not in conformance with our instructions may be dangerous.

● ● ● ● ● ● **Ниппель спиральный рукав / Multispiral tail**

Страница / Page	16	16	17
			
	F432 MALE 24°	F032 FEMALE 24°	F132 90° Swept Elbow
	SFF	SFM	SFM-90°

Ниппеля спиральных рукавов: диаметры

Multispiral Inserts: Available Sizes

Multispiral	1/4"	3/8"	1/2"	5/8"	3/4"	1"
--------------------	-------------	-------------	-------------	-------------	-------------	-----------

Dimensions and general characteristics may be changed at any time without prior notice.

Data contained herein are for information purpose only, and it does not enlarge, amend or imply any warranty other than provided by us with the product
Any use of the product not in conformance with our instructions may be dangerous.

0019 Муфта обжимная (зачистная)

Swaged Ferrule (skive)

для рукава / for hose:
R9 - 4SP - 4SH

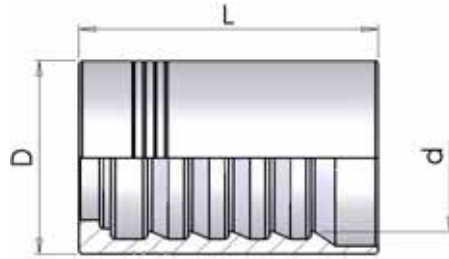

part number	hose I.D.		Dimension			skive	valid for
	in	mm	D	L	d	length	
0019-04	1/4	6,4	21,0	40,0	15,3	30	R9 - DIN 4SP - 4SH
0019-06	3/8	9,5	25,4	43,0	18,1	31	R9 - DIN 4SP - 4SH
0019-08	1/2	12,7	30,0	45,0	22,2	34	R9 - DIN 4SP - 4SH
0019-10	5/8	15,9	33,4	50,0	25,5	38	R9 - DIN 4SP - 4SH
0019-12	3/4	19	38,0	55,0	29,4	39	R9 - DIN 4SP - 4SH
0019-16	1	25,4	46,0	75,0	36,1	56	R9 - DIN 4SP - 4SH

BMC2 Муфта обжимная (не зачистная)

Swaged Ferrule (no skive)

для рукава / for hose:
4SP - 4SH

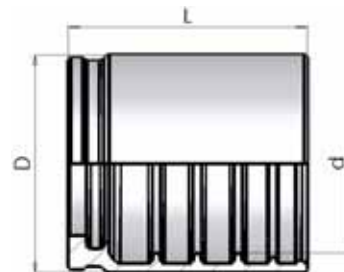

part number	hose I.D.		Dimension			skive	valid for
	in	mm	D	L	d	length	
BMC2-12	3/4	19	45,0	55,5	33,2	NO	4SP-4SH

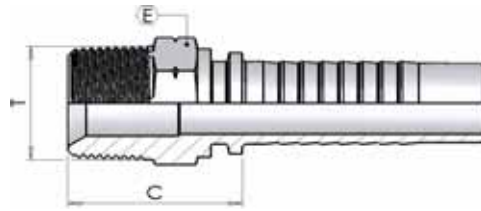
0370M Штуцер NPTF конус 60°
(AGN) NPTF Male 60° cone

part number	hose I.D.		Dimension			
			dash size	thread	hex	cut-off
	in	mm		T	E	C
0370M04-04	1/4	6,4	04	1/4-18	15	29
0370M04-06	1/4	6,4	04	3/8-18	19	29
0370M06-06	3/8	9,5	06	3/8-18	19	29
0370M08-08	1/2	12,7	08	1/2-14	22	35
0370M12-12	3/4	19	12	3/4-14	27	39
0370M16-16	1	25,4	16	1-11.1/2	36	46

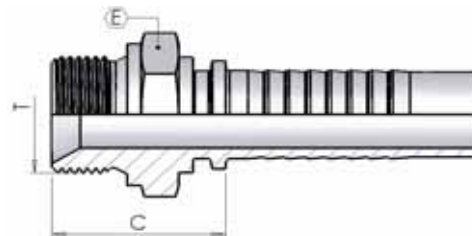
0350M Штуцер BSP конус 60°
(AGR) BSP Male Parallel 60° cone

part number	hose I.D.		Dimension			
			dash size	thread	hex	cut-off
	in	mm		T	E	C
0350M04-04	1/4	6,4	04	1/4-19	19	28
0350M06-06	3/8	9,5	06	3/8-19	22	30
0350M08-08	1/2	12,7	08	1/2-14	27	33
0350M10-10	5/8	15,9	10	5/8-14	30	35
0350M12-12	3/4	19	12	3/4-14	32	37
0350M16-16	1	25,4	16	1-11	41	42

0050M Ниппель BSP конус 60°

(DKR) BSP Female 60° cone Thrust Wire



O-Ring

(*) - Femmina BSP con O-Ring
 (*) - BSP female with O-Ring

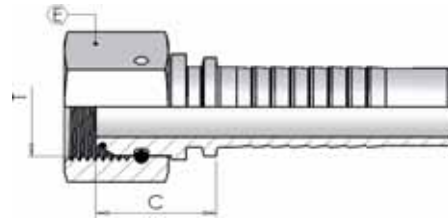

part number	hose I.D.		Dimension			
	in	mm	dash size	thread	hex	cut-off
				T	E	C
0050M04-04	1/4	6,4	04	1/4-19	19	20
0050M06-06	3/8	9,5	06	3/8-19	22	21
0050M08-08	1/2	12,7	08	1/2-14	27	23
0050M10-10	5/8	15,9	10	5/8-14	30	23
0050M12-12	3/4	19	12	3/4-14	32	27
(*) 0050M16-16	1	25,4	16	1-11	38	30

0150M Ниппель 90° BSP конус 60°

(DKR 90°) BSP 90° Swept Elbow 60° cone Thrust Wire



O-Ring

(*) - Femmina BSP con O-Ring
 (*) - BSP female with O-Ring

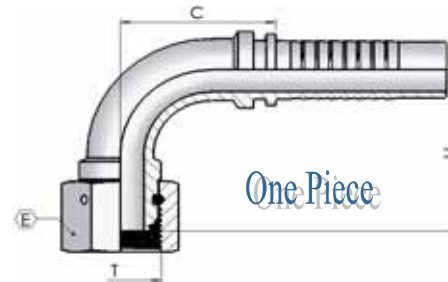

part number	hose I.D.		Dimension				
	in	mm	dash size	thread	hex	drop	cut-off
				T	E	H	C
0150M04-04	1/4	6,4	04	1/4-19	19	28	26
0150M06-06	3/8	9,5	06	3/8-19	22	34	35
0150M08-08	1/2	12,7	08	1/2-14	27	40	40
0150M10-10	5/8	15,9	10	5/8-14	30	46	46
0150M12-12	3/4	19	12	3/4-14	32	56	58
(*) 0150M16-16	1	25,4	16	1-11	38	68	72

0250M Ниппель 45° BSP конус 60°

(DKR 45°) BSP 45° Swept Elbow 60° cone Thrust Wire



O-Ring

(*) - Femmina BSP con O-Ring
 (*) - BSP female with O-Ring

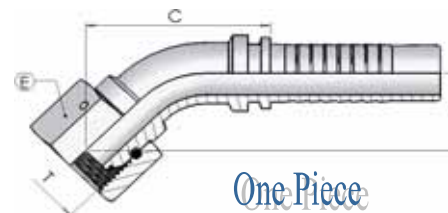

part number	hose I.D.		Dimension				
	in	mm	dash size	thread	hex	drop	cut-off
				T	E	H	C
0250M04-04	1/4	6,4	04	1/4-19	19	16	43
0250M06-06	3/8	9,5	06	3/8-19	22	19	54
0250M08-08	1/2	12,7	08	1/2-14	27	23	67
0250M10-10	5/8	15,9	10	5/8-14	30	24	70
0250M12-12	3/4	19	12	3/4-14	32	29	87
(*) 0250M16-16	1	25,4	16	1-11	38	35	108

0850M Штуцер JIC конус 74°

(AGJ) JIC Male 74° cone

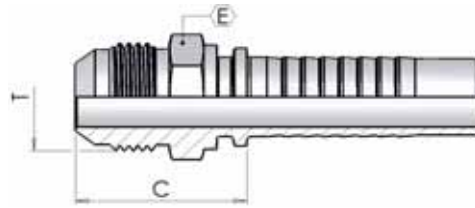

part number	hose I.D.		Dimension			
			dash size	thread	hex	cut-off
	in	mm		T	E	C
0850M04-04	1/4	6,4	04	7/16-20	12	28
0850M06-06	3/8	9,5	06	9/16-18	15	28
0850M06-08	3/8	9,5	06	3/4-16	19	32
0850M08-08	1/2	12,7	08	3/4-16	19	32
0850M08-10	1/2	12,7	08	7/8-14	24	36
0850M10-10	5/8	15,9	10	7/8-14	24	36
0850M10-12	5/8	15,9	10	1.1/16-12	27	40
0850M12-12	3/4	19	12	1.1/16-12	27	40
0850M12-16	1	25,4	16	1.5/16-12	34	43
0850M16-16	1	25,4	16	1.5/16-12	34	45

0900M Ниппель JIC конус 74°

(DKJ) JIC Female 74° cone Thrust Wire

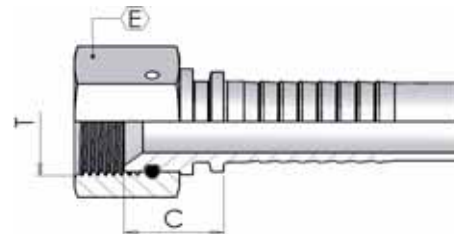

part number	hose I.D.		Dimension			
			dash size	thread	hex	cut-off
	in	mm		T	E	C
0900M04-04	1/4	6,4	04	7/16-20	17	16
0900M06-06	3/8	9,5	06	9/16-18	19	18
0900M08-08	1/2	12,7	08	3/4-16	24	20
0900M08-10	1/2	12,7	08	7/8-14	27	21
0900M10-10	5/8	15,9	10	7/8-14	27	21
0900M10-12	5/8	15,9	10	1.1/16-12	32	22
0900M12-12	3/4	19	12	1.1/16-12	32	23
0900M12-16	3/4	19	12	1.5/16-12	41	26
0900M16-16	1	25,4	16	1.5/16-12	41	27

0950M Ниппель 90° JIC конус 74°

(DKJ 90°) JIC 90° Swept Elbow 74° cone Thrust Wire

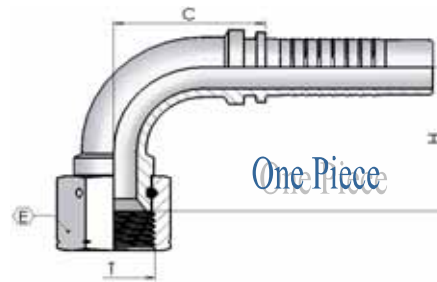

part number	hose I.D.		Dimension				
			dash size	thread T	hex E	drop H	cut-off C
	in	mm					
0950M04-04	1/4	6,4	04	7/16-20	17	26	26
0950M06-06	3/8	9,5	06	9/16-18	19	33	35
0950M08-08	1/2	12,7	08	3/4-16	24	39	40
0950M08-10	1/2	12,7	08	7/8-14	27	41	40
0950M10-10	5/8	15,9	10	7/8-14	27	45	46
0950M12-12	3/4	19	12	1.1/16-12	32	54	58
0950M16-16	1	25,4	16	1.5/16-12	41	68	72

1000M Ниппель 45° JIC конус 74°

(DKJ 45°) JIC 45° Swept Elbow 74° cone Thrust Wire

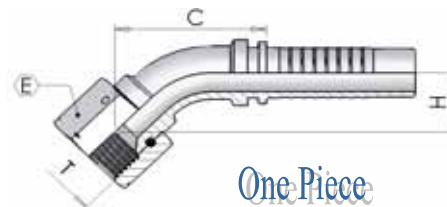

part number	hose I.D.		Dimension				
			dash size	thread T	hex E	drop H	cut-off C
	in	mm					
1000M04-04	1/4	6,4	04	7/16-20	17	15	42
1000M06-06	3/8	9,5	06	9/16-18	19	18	53
1000M08-08	1/2	12,7	08	3/4-16	24	23	66
1000M08-10	1/2	12,7	08	7/8-14	27	23	67
1000M10-10	5/8	15,9	10	7/8-14	27	23	69
1000M12-12	3/4	19	12	1.1/16-12	32	28	85
1000M16-16	1	25,4	16	1.5/16-12	41	36	109

0500M Штуцер метрика 24° L

(CEL) Metric Male 24° Seat Light

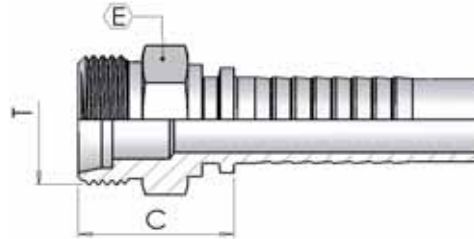

part number	hose I.D.		Dimension				
			dash size	thread T	erm.	hex E	cut-off C
	in	mm					
0500M08-22	1/2	12,7	08	M22-1.5	15	22	26
0500M10-26	5/8	15,9	10	M30-2	18	27	27
0500M12-30	3/4	19	12	M36-2	22	30	34
0500M16-36	1	25,4	16	M36-2	28	36	34

0085M Ниппель метрика 24° L

(DKOL) Metric Female 24° Seat Light

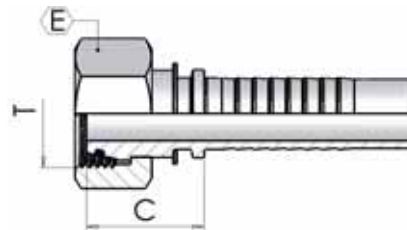

part number	hose I.D.		Dimension				
			dash size	thread T	erm.	hex E	cut-off C
	in	mm					
0085M06-18	3/8	9,5	06	M18-1.5	12	22	25
0085M08-22	1/2	12,7	08	M22-1.5	15	27	29
0085M10-26	5/8	15,9	10	M26-1.5	18	32	29
0085M12-30	3/4	19	12	M30-2	22	36	31
0085M16-36	1	25,4	16	M36-2	28	41	32

0185M Ниппель 90° метрика 24° L

(DKOL 90°) 90° Metric Swept Elbow 24° Seat Light

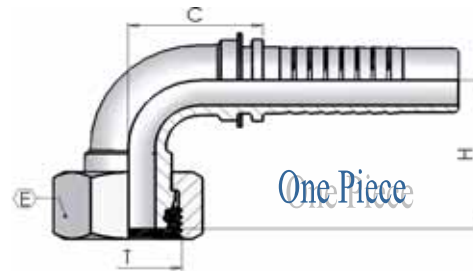

part number	hose I.D.		Dimension					
			dash size	thread T	erm.	hex E	drop H	cut-off C
	in	mm						
0185M06-18	3/8	9,5	06	M18-1.5	12	22	33	35
0185M08-22	1/2	12,7	08	M22-1.5	15	27	37	44
0185M10-26	5/8	15,9	10	M26-1.5	18	32	44	47
0185M12-30	3/4	19	12	M30-2	22	36	52	59
0185M16-36	1	25,4	16	M36-2	28	41	63	74

0285M Ниппель 45° метрика 24° L

(DKOL 45°) 45° Metric Swept Elbow 24° Seat Light

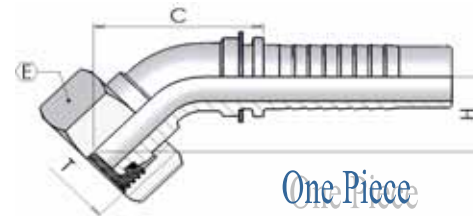

part number	hose I.D.		Dimension					
			dash size	thread T	erm.	hex E	drop H	cut-off C
	in	mm						
0285M06-18	3/8	9,5	06	M18-1.5	12	22	21	54
0285M08-22	1/2	12,7	08	M22-1.5	15	27	21	80
0285M10-26	5/8	15,9	10	M26-1.5	18	32	24	71
0285M12-30	3/4	19	12	M30-2	22	36	27	85
0285M16-36	1	25,4	16	M36-2	28	41	35	105

0450M Штуцер метрический конус 24°, S

(CES) Metric Male 24° Seat Heavy

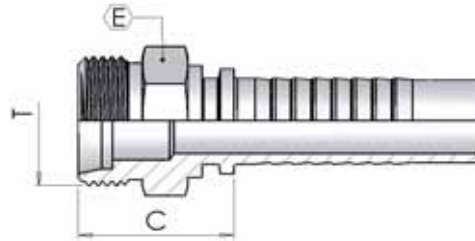

part number	hose I.D.		Dimension				
			dash size	thread T	erm.	hex E	cut-off C
	in	mm					
0450M08-24	1/2	12,7	08	M24-1.5	16	24	32
0450M10-30	5/8	15,9	10	M30-2	20	30	34
0450M12-30	3/4	19	12	M30-2	20	36	36
0450M12-36	3/4	19	12	M36-2	25	36	40
0450M16-42	1	25,4	16	M42-2	30	46	44

0084M Ниппель метрический, конус 24°, S

(DKOS) Metric Female 24° Seat Heavy

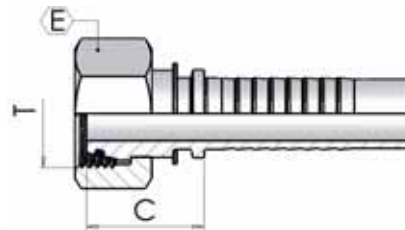

part number	hose I.D.		Dimension				
			dash size	thread T	erm.	hex E	cut-off C
	in	mm					
0084M04-16	1/4	6,4	04	M16-1.5	8	19	27
0084M06-20	3/8	9,5	06	M20-1.5	12	24	25
0084M08-24	1/2	12,7	08	M24-1.5	16	30	29
0084M10-30	5/8	15,9	10	M30-2	20	36	34
0084M12-30	3/4	19	12	M30-2	20	36	35
0084M12-36	3/4	19	12	M36-2	25	46	41
0084M16-36	1	25,4	16	M36-2	25	46	43
0084M16-42	1	25,4	16	M42-2	30	50	45

0184M Ниппель метрический 90°, конус 24°, S
(DKOS 90°)

90° Metric Swept Elbow 24° Seat Heavy

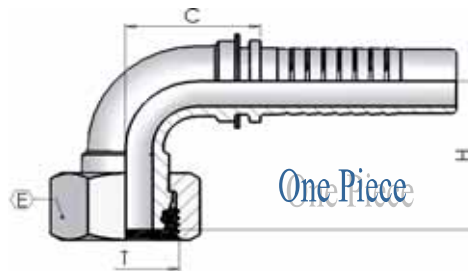

part number	hose I.D.		Dimension					
			dash size	thread T	erm.	hex E	drop H	cut-off C
	in	mm						
0184M04-16	1/4	6,4	04	M16-1.5	8	19	26	28
0184M06-20	3/8	9,5	06	M20-1.5	12	24	33	35
0184M08-24	1/2	12,7	08	M24-1.5	16	30	38	42
0184M10-30	5/8	15,9	10	M30-2	20	36	50	47
0184M12-30	3/4	19	12	M30-2	20	36	56	59
0184M12-36	3/4	19	12	M36-2	25	46	59	58
0184M16-42	1	25,4	16	M42-2	30	50	67	74

0284M Ниппель метрический 45°, конус 24°, S
(DKOS 45°)

45° Metric Swept Elbow 24° Seat Heavy

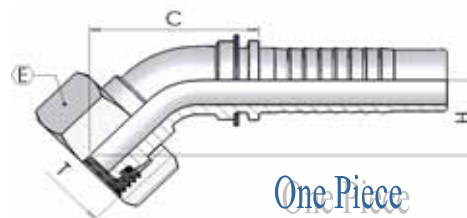

part number	hose I.D.		Dimension					
			dash size	thread T	erm.	hex E	drop H	cut-off C
	in	mm						
0284M04-16	1/4	6,4	04	M16-1.5	8	19	15	38
0284M06-20	3/8	9,5	06	M20-1.5	12	24	19	45
0284M08-24	1/2	12,7	08	M24-1.5	16	30	21	64
0284M10-30	5/8	15,9	10	M30-2	20	36	29	74
0284M12-30	3/4	19	12	M30-2	20	36	30	91
0284M12-36	3/4	19	12	M36-2	25	46	31	91
0284M16-42	1	25,4	16	M42-2	30	50	33	107

1250M Фланец SEA 3000 PSI прямой

(SFL) Straight SAE Flange 3000 PSI

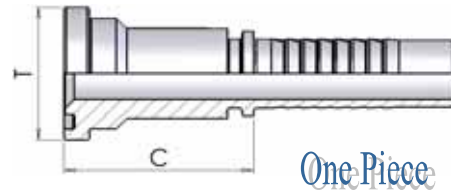

part number	hose I.D.		Dimension				
			dash size	flange		cut-off C	
	in	mm		T	mm		
1250M08-08	1/2	12,7	08	1/2	30,2	46	
1250M08-12	1/2	12,7	08	3/4	38.1	50	
1250M10-12	5/8	15,9	10	3/4	38.1	50	
1250M12-12	3/4	19	12	3/4	38.1	51	
1250M12-16	3/4	19	12	1	44.5	54	
1250M16-16	1	25,4	16	1	44.5	56	
1250M16-20	1	25,4	16	1.1/4	50.8	59	

1050M Фланец SEA 3000 PSI 90°

(SFL 90°) 90° SAE Flange 3000 PSI

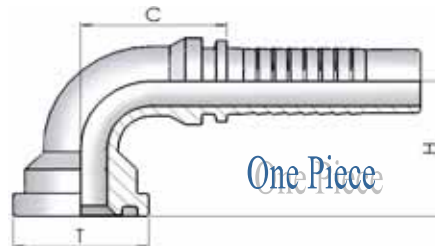

part number	hose I.D.		Dimension				
			dash size	flange		drop	cut-off
	in	mm		T	mm	H	C
1050M08-08	1/2	12,7	08	1/2	30,2	39	40
1050M08-12	1/2	12,7	08	3/4	38.1	44	40
1050M10-12	5/8	15,9	10	3/4	38.1	47	46
1050M12-12	3/4	19	12	3/4	38.1	53	58
1050M12-16	3/4	19	12	1	44.5	58	58
1050M16-16	1	25,4	16	1	44.5	65	72
1050M16-20	1	25,4	16	1.1/4	50.8	70	72

1150M Фланец SEA 3000 PSI 45°

(SFL 45°) 45° SAE Flange 3000 PSI

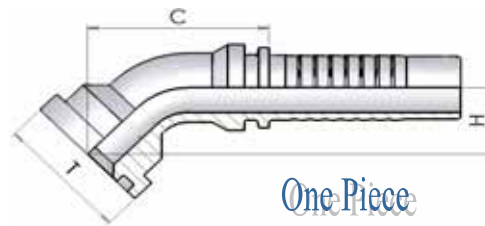

part number	hose I.D.		Dimension				
			dash size	flange		drop	cut-off
	in	mm		T	mm	H	C
1150M08-08	1/2	12,7	08	1/2	30,2	22	63
1150M08-12	1/2	12,7	08	3/4	38.1	25	69
1150M10-12	5/8	15,9	10	3/4	38.1	24	70
1150M12-12	3/4	19	12	3/4	38.1	27	84
1150M12-16	3/4	19	12	1	44.5	30	88
1150M16-16	1	25,4	16	1	44.5	33	106
1150M16-20	1	25,4	16	1.1/4	50.8	37	110

1300M Фланец SEA 6000 PSI прямой

(SFS) Straight SAE Flange 6000 PSI

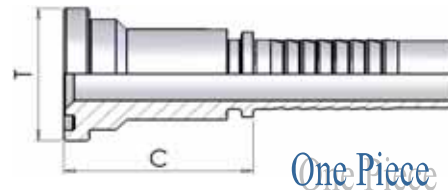

part number	hose I.D.		Dimension				
			dash size	flange			cut-off
	in	mm		T	mm		C
1300M08-08	1/2	12,7	08	1/2	31,8		47
1300M08-12	1/2	12,7	08	3/4	41,3		54
1300M10-12	5/8	15,9	10	3/4	41,3		54
1300M12-12	3/4	19	12	3/4	41,3		55
1300M12-16	3/4	19	12	1	47,6		61
1300M12-20	3/4	19	12	1.1/4	54		69
1300M16-12	1	25,4	16	3/4	41,3		57
1300M16-16	1	25,4	16	1	47,6		63
1300M16-20	1	25,4	16	1.1/4	54		70

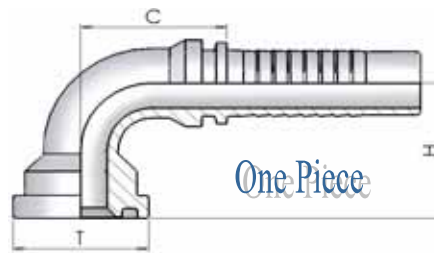
1100M Фланец SEA 6000 PSI 90°
(SFS 90°) 90° SAE Flange 6000 PSI

part number	hose I.D.		Dimension				
			dash size	flange		drop	cut-off
	in	mm			T	mm	H
1100M08-08	1/2	12,7	08	1/2	31,8	39	40
1100M08-12	1/2	12,7	08	3/4	41,3	48	40
1100M10-12	5/8	15,9	10	3/4	41,3	51	46
1100M12-12	3/4	19	12	3/4	41,3	57	58
1100M12-16	3/4	19	12	1	47,6	63	56
1100M16-12	1	25,4	16	3/4	41,3	64	72
1100M16-16	1	25,4	16	1	47,6	69	72
1100M16-20	1	25,4	16	1.1/4	54	77	72

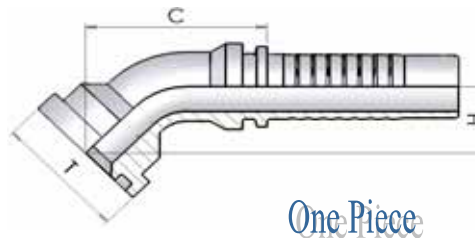
1200M Фланец SEA 6000 PSI 45°
(SFS 45°) 45° SAE Flange 6000 PSI

part number	hose I.D.		Dimension				
			dash size	flange		drop	cut-off
	in	mm			T	mm	H
1200M08-08	1/2	12,7	08	1/2	31,8	22	66
1200M08-12	1/2	12,7	08	3/4	41,3	28	70
1200M10-12	5/8	15,9	10	3/4	41,3	27	73
1200M12-12	3/4	19	12	3/4	41,3	30	87
1200M12-16	3/4	19	12	1	47,6	34	94
1200M16-12	1	25,4	16	3/4	41,3	35	103
1200M16-16	1	25,4	16	1	47,6	37	109
1200M16-20	1	25,4	16	1.1/4	54	41	115

130SM Фланец "CAT" прямой

(SFC) Straight 'CAT' Flange

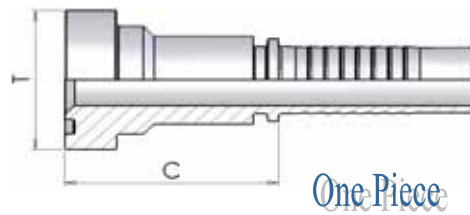

part number	hose I.D.		Dimension			
			dash size	flange		cut-off C
	in	mm		T	mm	
130SM12-12	3/4	19	12	3/4	41	59
130SM12-16	3/4	19	12	1	48	66
130SM16-16	1	25,4	16	1	48	67
130SM16-20	1	25,4	16	1.1/4	54	75

110SM Фланец "CAT" 90°

(SFC 90°) 90° 'CAT' Flange

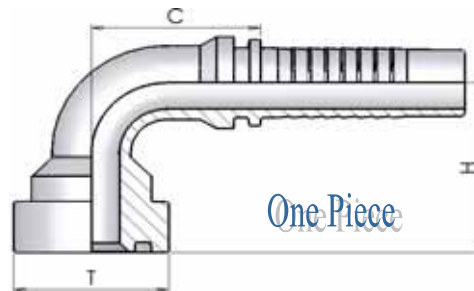

part number	hose I.D.		Dimension				
			dash size	flange		drop H	cut-off C
	in	mm		T	mm		
110SM12-12	3/4	19	12	3/4	41	60	58
110SM12-16	3/4	19	12	1	48	67	58
110SM16-16	1	25,4	16	1	48	74	80
110SM16-20	1	25,4	16	1.1/4	54	80	79

120SM Фланец "CAT" 45°

(SFC 45°) 45° 'CAT' Flange

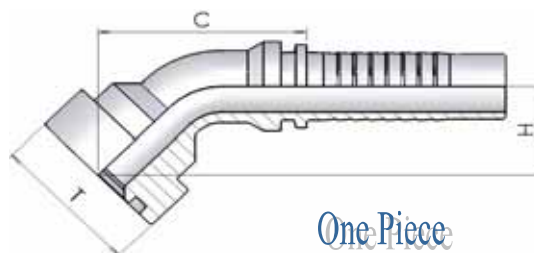

part number	hose I.D.		Dimension				
			dash size	flange		drop H	cut-off C
	in	mm		T	mm		
120SM12-12	3/4	19	12	3/4	41	32	90
120SM12-16	3/4	19	12	1	48	33	97
120SM16-16	1	25,4	16	1	48	40	121
120SM16-20	1	25,4	16	1.1/4	54	44	124

F432M

F434M

(SFF)

Фланец POCLAIN штуцер

POCLAIN Male Flange

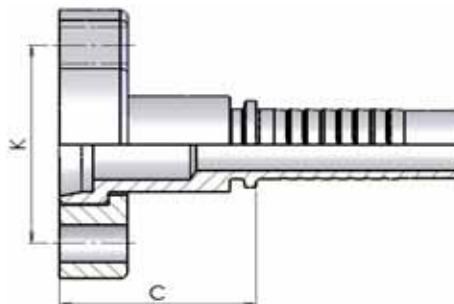

part number	hose I.D.		Dimension					
	in	mm	dash size	flange T			dim K	cut-off C
F432M08-08	1/2	12,7	08	1/2			44	41
F432M10-10	5/8	15,9	10	5/8			44	41
F432M12-12	3/4	19	12	3/4			56	52
F432M16-16	1	25,4	16	1			64	64
F432M20-20	1.1/4	31,8	20	1.1/4			74	70
F434M08-08	1/2	12,7	08	1/2			40	41
F434M10-10	5/8	15,9	10	5/8			40	41
F434M12-12	3/4	19	12	3/4			51	52
F434M16-16	1	25,4	16	1			57	64
F434M20-20	1.1/4	31,8	20	1.1/4			67	70

F032M

F034M

(SFM)

Фланец POCLAIN ниппель

POCLAIN Female Flange

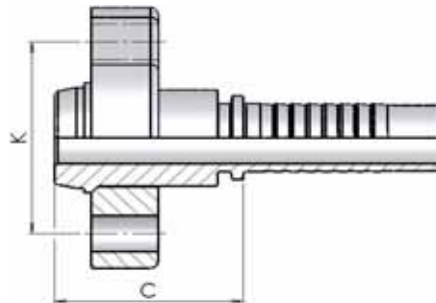

part number	hose I.D.		Dimension					
	in	mm	dash size	flange T			dim K	cut-off C
F032M08-08	1/2	12,7	08	1/2			44	45
F032M10-10	5/8	15,9	10	5/8			44	44
F032M12-12	3/4	19	12	3/4			56	51
F032M16-16	1	25,4	16	1			64	62
F032M20-20	1.1/4	31,8	20	1.1/4			74	82
F034M08-08	1/2	12,7	08	1/2			40	45
F034M10-10	5/8	15,9	10	5/8			40	44
F034M12-12	3/4	19	12	3/4			51	51
F034M16-16	1	25,4	16	1			57	62
F034M20-20	1.1/4	31,8	20	1.1/4			67	82

F132M

Фланец POCLAIN ниппель 90°

F134M

90° POCLAIN Female Flange

(SFM 90°)

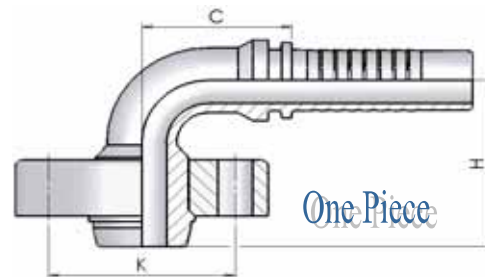

part number	hose I.D.		Dimension						
			dash size	flange T			dim K	drop H	cut-off C
	in	mm							
F132M08-08	1/2	12,7	08	1/2			44	50	40
F132M10-10	5/8	15,9	10	5/8			44	52	48
F132M12-12	3/4	19	12	3/4			56	62	63
F132M16-16	1	25,4	16	1			64	81	80
F132M20-20	1.1/4	31,8	20	1.1/4			74	96	98
F134M08-08	1/2	12,7	08	1/2			40	50	40
F134M10-10	5/8	15,9	10	5/8			40	52	48
F134M12-12	3/4	19	12	3/4			51	62	63
F134M16-16	1	25,4	16	1			57	81	80
F134M20-20	1.1/4	31,8	20	1.1/4			67	96	98

